

I接头



成品订购码

F-M16X150 I

① ② ③ ④

① 附件编号	② 螺纹规格	③ 螺纹牙距	④ 附件类别
	M3: M3	050: 0.5mm	I: I接头
	M4: M4	070: 0.7mm	
	M5: M5	080: 0.8mm	
	M6: M6	100: 1.0mm	
	M8: M8	125: 1.25mm	
	M10: M10		
	M12: M12		
	M14: M14		
	M16: M16	150: 1.5mm	
	M18: M18		
	M20: M20		
	M22: M22		
	M26: M26	200: 2.0mm	
	M27: M27		
	M36: M36		
	M42: M42		

I接头与气缸配套表

气缸系列 附件名称	SE						SAI									
	32	40	50	63	80	100	125	32	40	50	63	80	100	125	160	200
F-M10X125I	●							●								
F-M12X125I		●							●							
F-M16X150I			●	●						●	●					
F-M20X150I					●	●						●	●			
F-M27X200I							●							●		
F-M36X200I															●	●

气缸系列 附件名称	SG/SGC				SC/SAU				SC				JSI									
	125	160	200	250	32	40	50	63	80	100	125	160	200	250	32	40	50	63	80	100	125	
F-M10X125I						●									●							
F-M12X125I							●															
F-M14X150I									●													
F-M16X150I										●												
F-M18X150I																				●	●	
F-M20X150I																						
F-M22X150I																						
F-M26X150I																						
F-M27X200I																						
F-M36X200I																						
F-M42X200I																						

气缸系列 附件名称	MI						MPG						
	8	10	12	16	20	25	32	40	6	8	10	12	16
F-M3X050I										●			
F-M4X070I	●	●									●	●	
F-M5X080I													●
F-M6X100I			●	●									
F-M8X125I					●								
F-M10X125I						●	●						
F-M12X125I							●						

外部规格

M14\M18\M22\M26

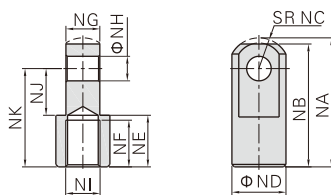

型号\符号	NA	NB	NC	ND	NE	NF	NG	NH	NJ	NK	NI
F-M14X150I	52.5	50	12.5	22	21	19	13.8	10	19	40	M14 × 1.5
F-M18X150I	66.5	64	16.5	28	27	24	19.8	14	24	50	M18 × 1.5
F-M22X150I	83.5	80	23.5	40	29	26	29.8	22	34	60	M22 × 1.5
F-M26X150I	83.5	80	23.5	40	29	26	29.8	22	34	60	M26 × 1.5

其它规格

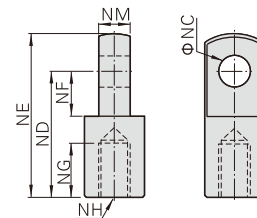

型号\符号	NC	ND	NE	NF	NG	NH	NM
F-M3x050I	3	12	15.5	5	5	M3 × 0.5	3
F-M4x070I	4	16	21	6.8	8	M4 × 0.7	4
F-M5x080I	5	25	32	14.1	7.5	M5 × 0.8	6.3
F-M6x100I	6	21	28	8.5	8	M6 × 1.0	6
F-M8x125I	8	30	40	11	15	M8 × 1.25	8
F-M10x125I	10	40	50	15	20	M10 × 1.25	10
F-M12x125I	12	48	62	24	20	M12 × 1.25	12
F-M16x150I	16	64	82	32	23	M16 × 1.5	16
F-M20x150I	20	80	102	40	30	M20 × 1.5	20
F-M27x200I	30	110	139	51	45	M27 × 2.0	30
F-M36x200I	35	144	181	65	55	M36 × 2.0	35
F-M42x200I	40	168	211	85	62	M42 × 2.0	40

Y接头



成品订购码

F-M16X150 Y



① 附件编号	② 螺纹规格	③ 螺纹牙距	④ 附件类别
	M3: M3	050: 0.5mm	Y: Y接头
	M4: M4	070: 0.7mm	
	M5: M5	080: 0.8mm	
	M6: M6	100: 1.0mm	
	M8: M8	125: 1.25mm	
	M10: M10		
	M12: M12		
	M14: M14		
	M16: M16	150: 1.5mm	
	M18: M18		
	M20: M20		
	M22: M22		
	M26: M26	200: 2.0mm	
	M27: M27		
	M36: M36		
	M42: M42		

Y接头与气缸配套表

气缸系列 附件名称	SE						SAI									
	32	40	50	63	80	100	125	32	40	50	63	80	100	125	160	200
F-M10X125Y	●							●								
F-M12X125Y		●							●							
F-M16X150Y			●	●						●	●					
F-M20X150Y					●	●						●	●			
F-M27X200Y							●							●		
F-M36X200Y															●	●

气缸系列 附件名称	SG/SGC				SC/SAU				SC				JSI					
	125	160	200	250	32	40	50	63	80	100	125	160	200	250	32	40	50	63
F-M10X125Y					●										●			
F-M12X125Y						●												
F-M14X150Y																	●	
F-M16X150Y								●	●									
F-M18X150Y																	●	●
F-M20X150Y									●	●								
F-M22X150Y																		●
F-M26X150Y																		●
F-M27X200Y	●																	●
F-M36X200Y		●	●															●
F-M42X200Y				●														●

气缸系列 附件名称	MI				MPG								
	8	10	12	16	20	25	32	40	6	8	10	12	16
F-M3X050Y										●			
F-M4X070Y	●	●									●	●	
F-M5X080Y													●
F-M6X100Y			●	●									●
F-M8X125Y					●								
F-M10X125Y						●	●						
F-M12X125Y								●					

外部规格

M10及以下

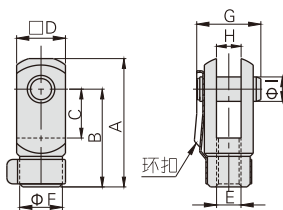

型号\符号	A	B	C	D	F
F-M3X050Y	15.5	12	5	6	6
F-M4X070Y	22	16	8	8	7
F-M5X080Y	28	21	10.2	12	10
F-M6X100Y	32	24	12	12	10
F-M8X125Y	42	32	16	16	14
F-M10X125Y	52	40	20	19	18

型号\符号	E	G	H	I
F-M3X050Y	M3×0.5	9	3	3
F-M4X070Y	M4×0.7	11.5	4	4
F-M5X080Y	M5×0.8	15.5	6.5	5
F-M6X100Y	M6×1.0	16	6	6
F-M8X125Y	M8×1.25	21	8	8
F-M10X125Y	M10×1.25	25	10	10

M14\M18\M22\M26

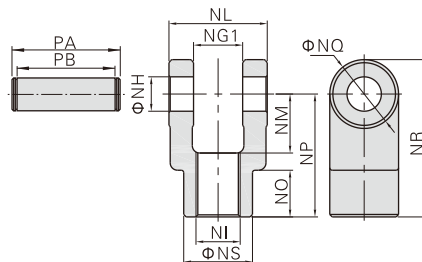

型号\符号	NG1	NH	NI	NL	NM
F-M14X150Y	14.2	10	M14×1.5	27.8	19
F-M18X150Y	20.2	14	M18×1.5	39.8	24
F-M22X150Y	30.2	22	M22×1.5	59.8	34
F-M26X150Y	30.2	22	M26×1.5	59.8	34

型号\符号	NO	NP	NQ	NR	NS	PA	PB
F-M14X150Y	17	40	22	51	22	34.6	28.8
F-M18X150Y	19	50	28	64	28	47	40.8
F-M22X150Y	20	65	40	85	40	69.2	60.8
F-M26X150Y	20	65	40	85	40	69.2	60.8

其它规格

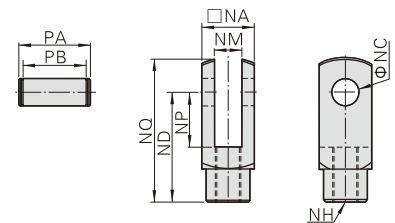

型号\符号	NA	NC	ND	NP	NQ
F-M12X125Y	25.4	12	48	24	62
F-M16X150Y	32	16	64	32	80
F-M20X150Y	44.4	20	80	40	101
F-M27X200Y	54	30	110	55	139
F-M36X200Y	70	35	144	73	179
F-M42X200Y	85	40	168	86	211

型号\符号	NM	NH	PA	PB
F-M12X125Y	12	M12×1.25	32.4	26.2
F-M16X150Y	16	M16×1.5	39	32.8
F-M20X150Y	20	M20×1.5	53.4	45.2
F-M27X200Y	30	M27×2.0	64.2	54.8
F-M36X200Y	35	M36×2.0	80.2	70.8
F-M42X200Y	40.3	M42×2.0	115	93

鱼眼接头



成品订购码

F-M10X125 U



① 附件编号	② 螺纹规格	③ 螺纹牙距	④ 附件类别
	M4: M4	070: 0.7mm	U: 鱼眼接头
	M5: M5	080: 0.8mm	
	M6: M6	100: 1.0mm	
	M8: M8	125: 1.25mm	
	M10: M10		
	M12: M12		
	M14: M14		
	M16: M16	150: 1.5mm	
	M18: M18		
	M20: M20		
	M26: M26		
	M27: M27	200: 2.0mm	
	M36: M36		

鱼眼接头与气缸配套表

气缸系列 附件名称	SE						SAI					SAI/SC				
	32	40	50	63	80	100	125	32	40	50	63	80	100	125	160	200
F-M10X125U	●							●								
F-M12X125U		●							●							
F-M16X150U			●	●						●	●					
F-M20X150U					●	●						●	●			
F-M27X200U							●							●		
F-M36X200U															●	●

气缸系列 附件名称	SG/SGC				SC/SAU					JSI							
	125	160	200	250	32	40	50	63	80	100	32	40	50	63	80	100	125
F-M10X125U					●						●						
F-M12X125U						●											
F-M14X150U												●					
F-M16X150U							●	●									
F-M18X150U													●	●			
F-M20X150U									●	●							
F-M26X150U																●	
F-M27X200U	●																●
F-M36X200U		●	●														

气缸系列 附件名称	ACQ									
	12	16	20	25	32	40	50	63	80	100
F-M5X080U	●									
F-M6X100U		●								
F-M8X125U			●							
F-M10X125U				●						
F-M14X150U					●	●				
F-M18X150U							●	●		
F-M26X150U									●	

气缸系列 附件名称	MA				MF				MBL									
	16	20	25	32	40	50	63	80	20	25	32	40	20	25	32	40	50	63
F-M6X100U	●																	
F-M8X125U		●						●					●					
F-M10X125U			●	●					●	●				●	●			
F-M12X125U					●											●		
F-M14X150U						●	●				●						●	●

气缸系列 附件名称	PB				MI								
	4	6	10	12	16	8	10	12	16	20	25	32	40
F-M4X070U			●										
F-M5X080U				●	●								
F-M6X100U									●	●			
F-M8X125U										●			
F-M10X125U											●	●	
F-M12X125U													●

外部规格

M8及以下规格

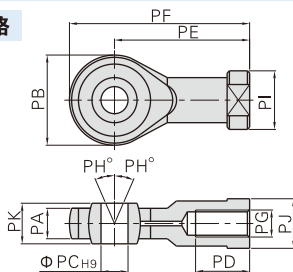

M10及以上规格

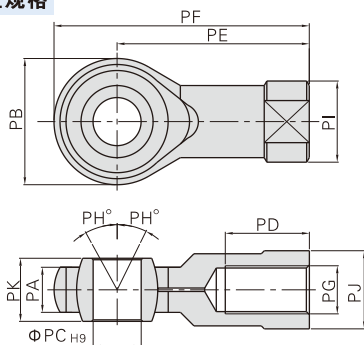

型号\符号	PA	PB	PC	PD	PE	PF	PG	PH	PI	PJ	PK
F-M4X070U	6	18	5	10	27	36	M4×0.7	13	12.5	10	8
F-M5X080U	6	18	5	10	27	36	M5×0.8	13	12.5	10	8
F-M6X100U	6.8	20	6	12	30	40	M6×1.0	13	13	11	9
F-M8X125U	9	24	8	16	36	48	M8×1.25	13	16	14	12
F-M10X125U	11	26	10	20	43	56	M10×1.25	13	19	17	14
F-M12X125U	12	32	12	22	50	66	M12×1.25	13	22	19	16
F-M14X150U	14	36	14	28	57	75	M14×1.5	13	25	22	19
F-M16X150U	15	40	16	28	64	84	M16×1.5	15	27	22	21
F-M18X150U	16.5	46	18	30	71	94	M18×1.5	15	31	27	23
F-M20X150U	18	46	20	33	77	100	M20×1.5	15	34	30	25
F-M26X150U	22	60	25	48	94	124	M26×1.5	15	42	36	31
F-M27X200U	25	70	30	51	110	145	M27×2.0	15	50	41	37
F-M36X200U	27.5	80	35	56	125	165	M36×2.0	15	57.5	50	43