

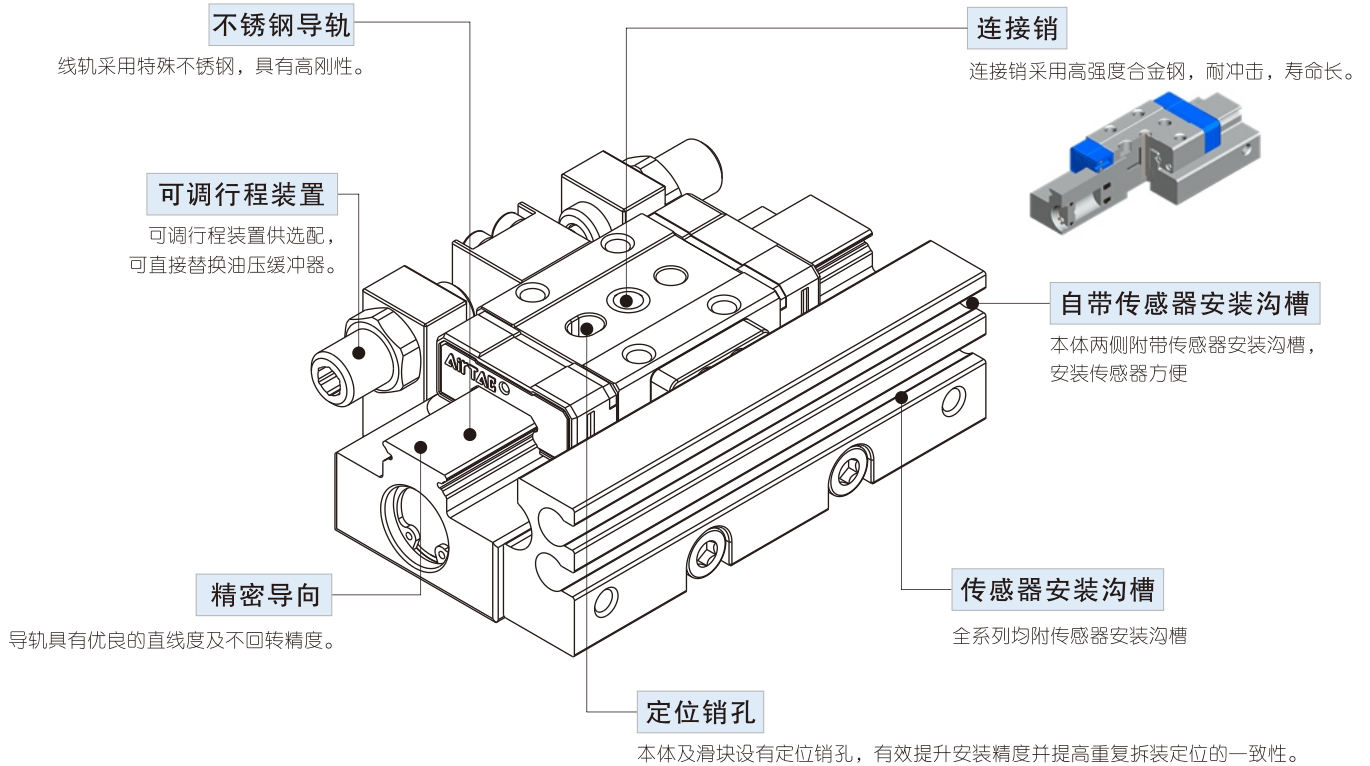

HGS系列产品概览



安装与使用(通用性)



- 1、气缸配管前，必须清除管内杂物，防止杂物进入气缸内；
- 2、气缸使用介质应经过40 μm以上滤芯过滤后方可使用；
- 3、在低温环境下，应采取抗冻措施，防止系统中的水分冻结；
- 4、气缸拆下长时间不使用，要注意表面防锈，进排气口应加防尘堵塞帽，活塞杆及运动部位涂防锈油。

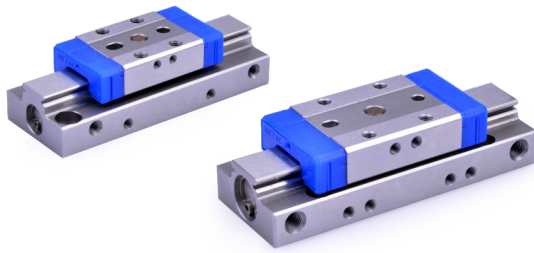

符号



产品特性

- 1、线轨采用特殊不锈钢，具有高刚性、耐腐蚀特性。
- 2、连接销采用高强度合金钢，耐冲击、寿命长。
- 3、可调行程装置供选配并可直接替换油压缓冲器。
- 4、导轨具有优良的直线度及不回转精度。
- 5、全系列规格皆有磁感附件供选配。
- 6、本体及滑块设有定位销孔有效提升安装精度并提高重复拆装定位的一致性。

成品订购码

HGS 10 × 15 S J

① ② ③ ④ ⑤

① 规格代号	② 缸径	③ 行程	④ 磁石代号	⑤ 行程调整装置
HGS: 微型精密滑台气缸	6	5 10	空白: 不附磁石及传感器固定座	空白: 无
	8	5 10 15 20	S: 附磁石及传感器固定座	J: 附行程调整装置 [注]
	10	5 10 15 20		
	12	5 10 15 20 25		

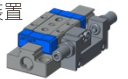
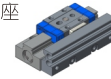

[注] Φ10/Φ12可增购油压缓冲器进行替换。

附件订购码

F-HGS 10 × 15 H

① ② ③ ④ ⑤

① 附件编号	② 气缸规格	③ 缸径	④ 行程	⑤ 附件类别
HGS: 微型精密滑台气缸		6	5 10	H: 传感器固定座成品包 (含磁石)
		8	5 10 15 20	
		10	5 10 15 20	
		12	5 10 15 20 25	

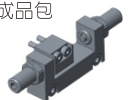
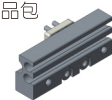

配套表:

		传感器				
		行程				
订购码		5	10	15	20	25
缸径	6	F-HGS6X5H	F-HGS6X10H			
	8	F-HGS8X5H	F-HGS8X10H	F-HGS8X15H	F-HGS8X20H	
	10	F-HGS10X5H	F-HGS10X10H	F-HGS10X15H	F-HGS10X20H	
	12	F-HGS12X5H		F-HGS12X15H	F-HGS12X20H	F-HGS12X25H

		行程调整螺丝				
		行程				
订购码		5	10	15	20	25
缸径	6	F-HGS6X5J	F-HGS6X10J			
	8	F-HGS8X5J	F-HGS8X10J	F-HGS8X15J		
	10	F-HGS10X5J	F-HGS10X10J	F-HGS10X15J		
	12	F-HGS10X10J		F-HGS10X15J		F-HGS10X15J

规格

内径(mm)	6	8	10	12
动作型式	复动型			
工作介质	空气(经40 μm以上滤网过滤)			
使用压力范围	0.2~0.7MPa(29~100psi)(2.0~7.0bar)	0.15~0.7MPa(22~100psi)(1.5~7.0bar)		
保证耐压力	1.2MPa(175psi)(12.0bar)			
缓冲型式	两端固定缓冲		两端固定缓冲、油压缓冲器缓冲	
工作温度	-20~70°C			
给油	不需要			
使用速度范围	50~500 mm/s			
行程公差范围	+0.5 0			
所配传感器	DMSHEMSH			
接管口径	M3 × 0.5		M5 × 0.8	

另: 传感器的选配详见P403页。

行程

内径(mm)	标准行程(mm)					最大行程
6	5 10					10
8	5 10 15 20					20
10	5 10 15 20					20
12	5 10 15 20 25					25

[注] 其它特殊行程请与本公司联系。

HGS系列

产品重量表

单位: 克(g)

型号	本体重量	传感器固定座 成品包重量	行程调整螺丝成品包		
			单个调整螺丝重量	单个油压缓冲器重量	其余配件重量
HGS6X5	116.1	14.25	2.4	-	11.61
HGS10X5	152.3	19.05	2.4	-	11.61
HGS8X5	133.01	14.05	2.4	-	10.34
HGS8X10	167.46	18.54	2.4	-	10.34
HGS8X15	207.07	23.35	2.4	-	10.34
HGS8X20	239.37	28.16	2.4	-	10.34
HGS10X5	194.26	15.91	6.8	16	27.36
HGS10X10	248.98	19.12	6.8	16	26.2
HGS10X15	303.39	24	6.8	16	21.8
HGS10X20	352.05	28.93	6.8	16	21.8
HGS12X5	291.01	21.64	6.8	16	27.36
HGS12X10	318.12	21.64	6.8	16	26.2
HGS12X15	356.79	27.63	6.8	16	21.8
HGS12X20	445.92	33.25	6.8	16	21.8
HGS12X25	491.34	38.87	6.8	16	21.8

重量计算范例:

HGS10X15SJ=本体重量+传感器固定座成品包重量+单个螺丝重量X2+其余配件重量
=303.39+24+6.8X2+21.8=362.79。

内部结构及主要零件材质

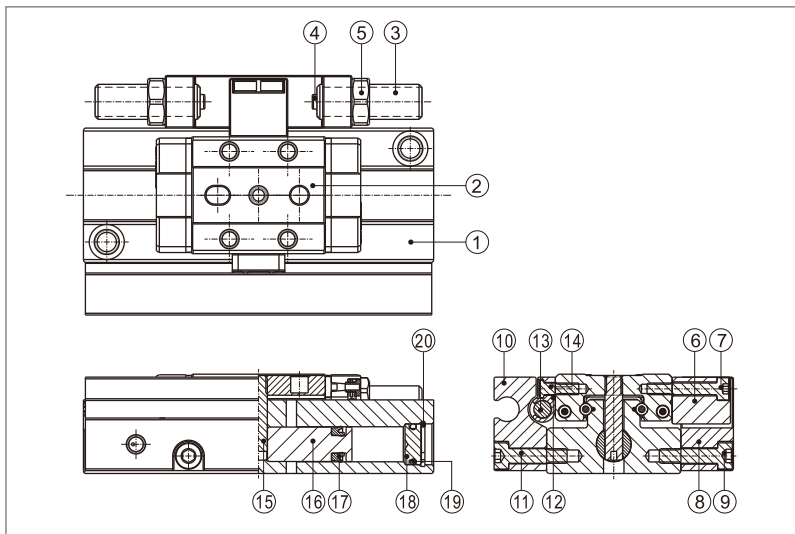

序号	名称	材质	序号	名称	材质
1	本体	不锈钢	11	内六角沉头螺丝	合金钢
2	滑块	不锈钢	12	磁铁固定座	工程塑料
3	行程调整螺丝	不锈钢	13	磁铁	稀土材料
4	防撞垫	NBR	14	十字圆头螺丝	合金钢
5	螺帽	不锈钢	15	连接销	不锈钢
6	中间挡块	快削钢	16	活塞	不锈钢
7	内六角沉头螺丝	合金钢	17	活塞O令	NBR
8	两端挡块	铝合金	18	端盖	不锈钢
9	内六角沉头螺丝	合金钢	19	O型环	NBR
10	传感器固定条	铝合金	20	C形孔用扣环	弹簧钢

平台精度

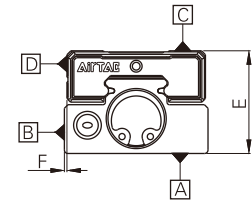

型号	HGS6	HGS8	HGS10	HGS12
平行度	对A面的C面		0.02	
	对B面的D面		0.02	
行走平行度	对A面的C面		0.004	
	对B面的D面		0.004	
E尺寸的公差			±0.05	
F尺寸的公差			±0.05	

最大容许装载重量

[单位: kg]

型号	HGS6	HGS8	HGS10	HGS12
无行程调整装置	0.3	0.3	0.8	1.2
附行程调整装置	0.2	0.3	0.8	1.2
附油压缓冲装置	-	-	1.6	2.0

最大容许力矩

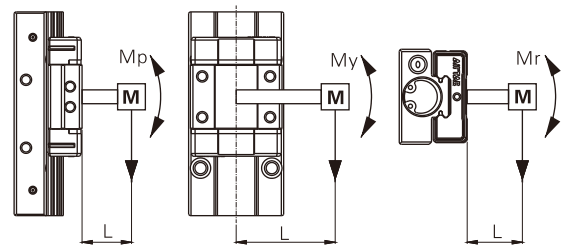

型号	最大容许力矩(N.m)		
	俯仰力矩Mp	摇摆力矩My	滚动力矩Mr
HGS6X5			
HGS6X10	0.42	0.42	0.87
HGS8X5			
HGS8X10	0.42	0.42	0.87
HGS8X15			
HGS8X20	1.7	1.7	1.8
HGS10X5			
HGS10X10	1.2	1.4	2.3
HGS10X15			
HGS10X20	2.8	3.1	3.3
HGS12X5			
HGS12X10	2.4	2.9	4.7
HGS12X15			
HGS12X20			
HGS12X25	6.5	7.7	7.3

HGS系列

平台的移位量

因俯仰力矩所造成的平台移位量

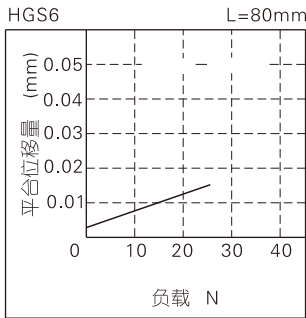
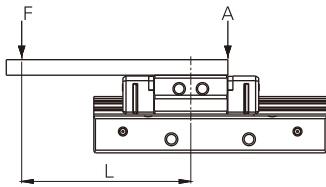

因滚动力矩所造成的平台移位量

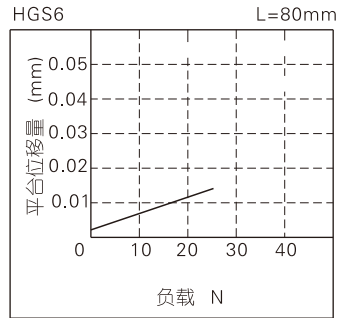
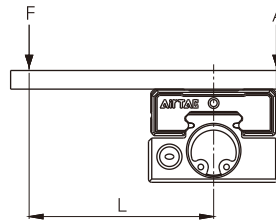

因摇摆力矩所造成的平台移位量

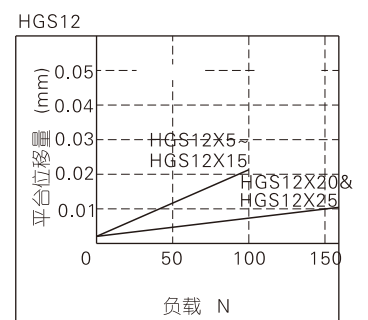
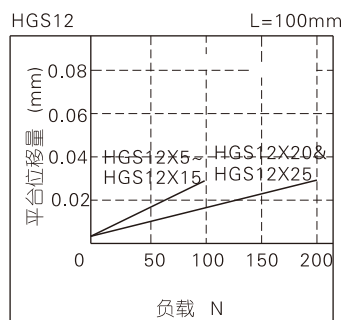
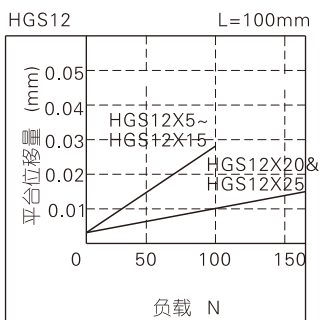
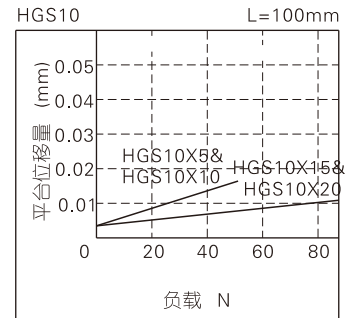
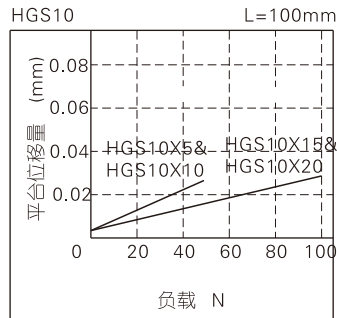
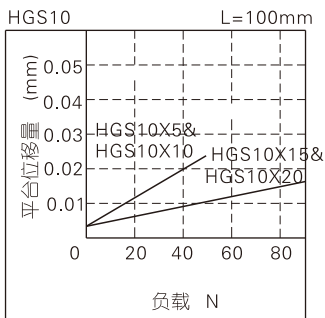
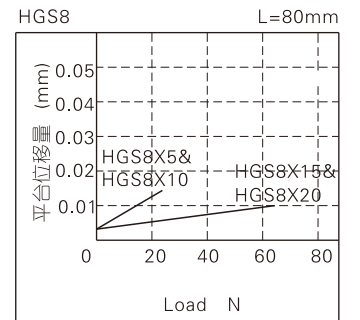
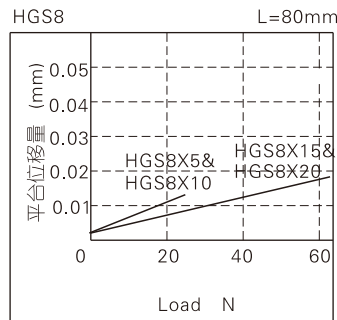
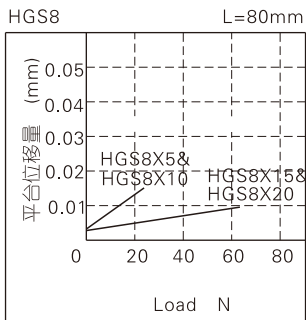
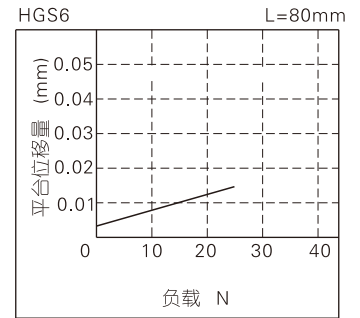
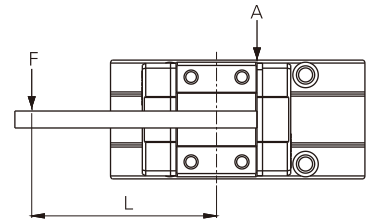

HGS系列

安装与使用

请下表选用合适长度的固定螺丝并按表中规定的锁紧力矩固定气缸，锁紧力矩过大会造成作动不良，锁紧力矩过小，会造成螺丝松脱导致锁附物位置偏移及掉落。

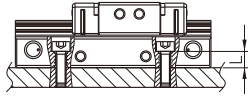

型号	使用螺栓规格	最大锁紧扭矩(N.m)	贯通孔长L(mm)
HGS6	M3X0.5	1.1	4.3
HGS8	M3X0.5	1.1	6.3
HGS10	M3X0.5	1.1	6
HGS12	M3X0.5/ M4X0.7	1.1/2.5	4.8

注: 型号HGS12行程5及10使用螺丝为M3X0.5。

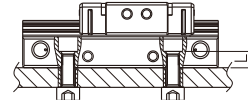

型号	使用螺栓规格	最大锁紧扭矩(N.m)	最大锁牙深度L(mm)
HGS6	M4X0.7	2.5	4.3
HGS8	M4X0.7	2.5	6.3
HGS10	M4X0.7	2.5	6
HGS12	M4X0.7/ M5X0.8	2.5/5.1	4.8

注: 型号HGS12行程5及10使用螺丝为M4X0.7。

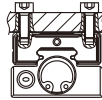

型号	使用螺栓规格	最大锁紧扭矩(N.m)	最大旋入深度(mm)
HGS6	M3X0.5	1.1	3
HGS8	M3X0.5	1.1	3
HGS10	M3X0.5	1.1	3
HGS12	M3X0.5	1.1	4

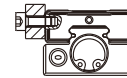

型号	使用螺栓规格	最大锁紧扭矩(N.m)	最大旋入深度(mm)
HGS6	M2X0.4	0.26	4
HGS8	M2X0.4	0.26	4
HGS10	M3X0.5	1.1	3
HGS12	M3X0.5	1.1	4

附件安装方式

参考下表中规定的固定力矩固定附件，锁紧力矩过大会造成零件损坏；锁紧力矩过小，会造成螺丝松脱导致锁附物位置偏移及掉落。

行程调整装置

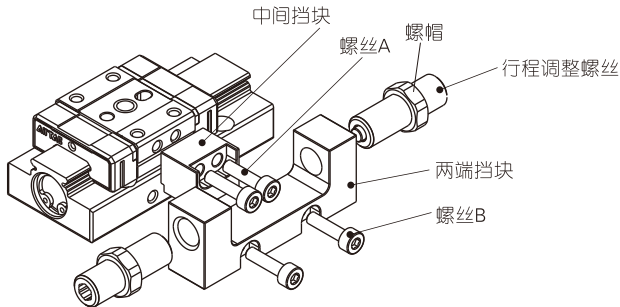

型号	螺丝A规格	螺丝A最大锁紧扭矩(N.m)	螺丝B规格	螺丝B最大锁紧扭矩(N.m)
HGS6	M2X0.4X10L	0.26	M2.5X0.45X10L	0.36
HGS8	M2X0.4X10L	0.26	M3X0.5X10L	1.1
HGS10	M3X0.5X12L	1.1	M3X0.5X12L	1.1
HGS12	M3X0.5X12L	1.1	M3X0.5X12L	1.1

*传感器装置两侧皆可安装，行程调整装置仅可安装于非气孔侧。

传感器装置

注意气孔转接密封件须正确安装，不可遗失或掉落，以免造成气压泄漏。

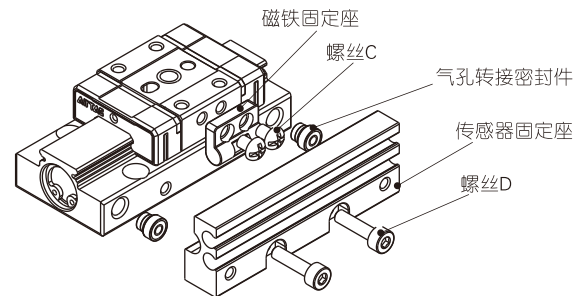

型号	螺丝C规格	螺丝C最大锁紧扭矩(N.m)	螺丝D规格	螺丝D最大锁紧扭矩(N.m)
HGS6	M2X0.4X6L	0.26	M2.5X0.45X10L	0.36
HGS8	M2X0.4X6L	0.26	M3X0.5X10L	1.1
HGS10	M3X0.5X4L	1.1	M3X0.5X10L	1.1
HGS12	M3X0.5X4L	1.1	M3X0.5X10L	1.1

油压缓冲器缓冲

- 1、油压缓冲器属于易耗品，当能量吸收能力下降时应及时更换，下表为各缸径所配油压缓冲器型号对照表：
- 2、油压缓冲器尾部螺孔并非调节之用，随意调节会造成油品泄漏。
- 3、请用下表规定的锁紧力矩锁紧油压缓冲器锁紧螺母。

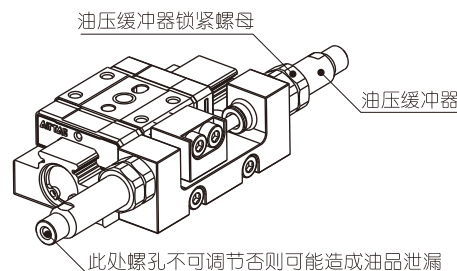

型号	缓冲器规格	锁紧扭矩(N.m)
HGS6	无油压缓冲器	
HGS8		
HGS10	ACA0806-1N	1.67
HGS12		

HGS系列

外部规格(HGS6)

HGS6X5

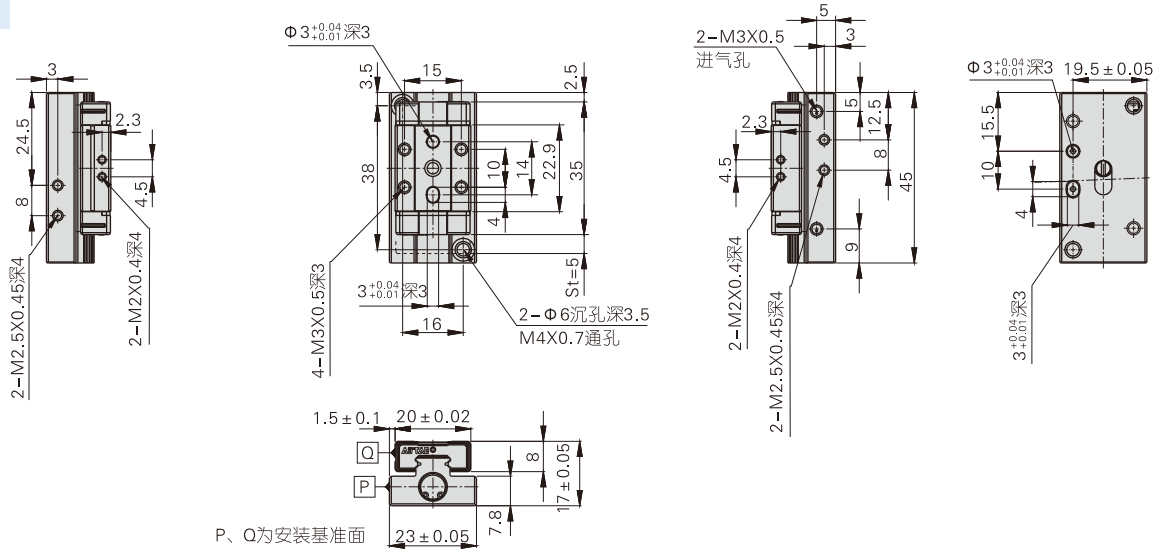

HGS6X5S

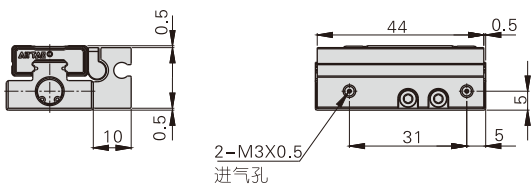

HGS6X5J

可调范围: 5mm

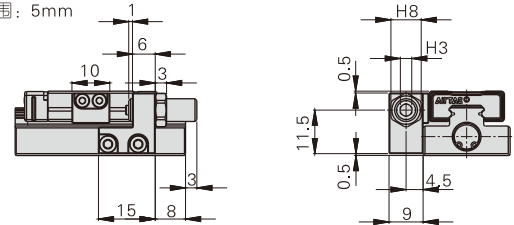

HGS6X10

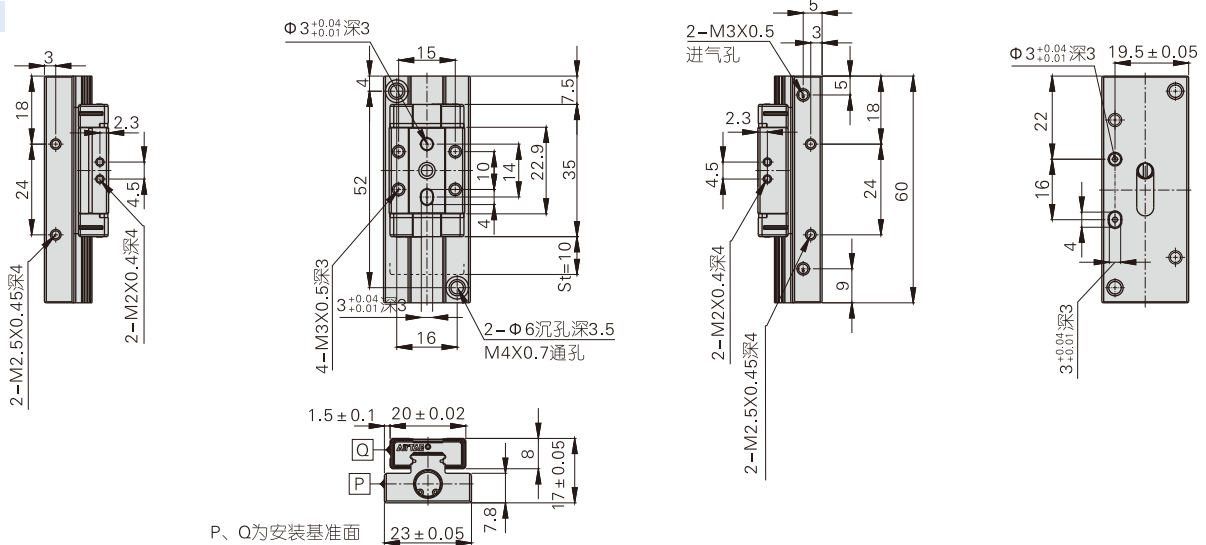

HGS6X10S

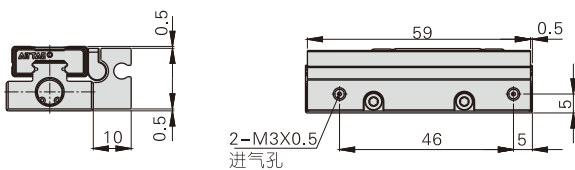

HGS6X10J

可调范围: 两侧各5mm

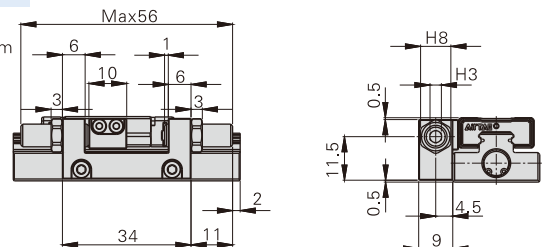

HGS系列

外部规格(HGS8)

HGS8X5

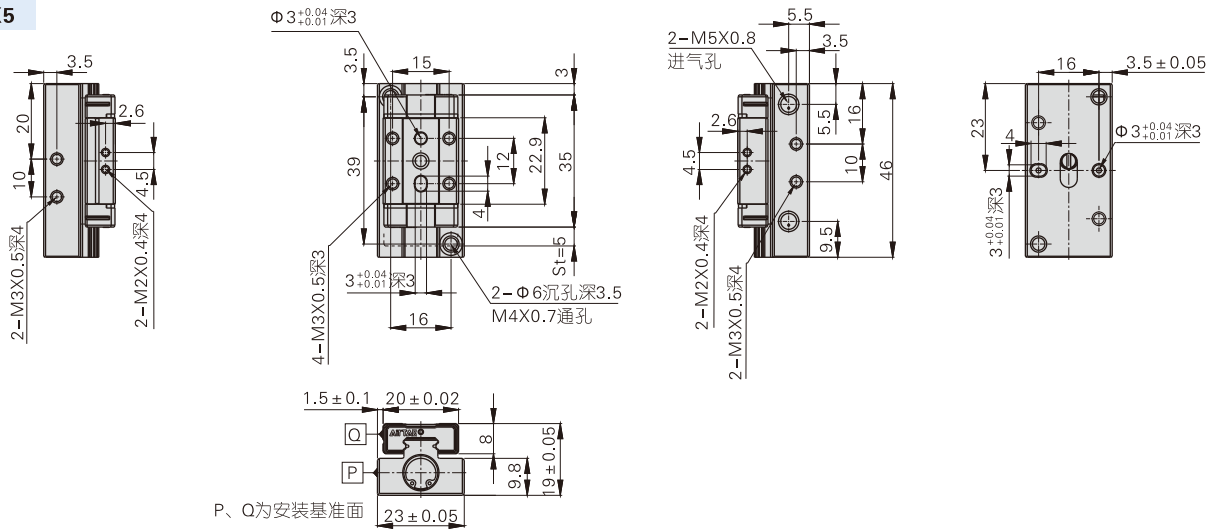

HGS8X5S

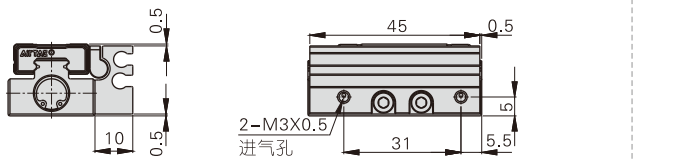

HGS8X5J

可调范围: 5mm

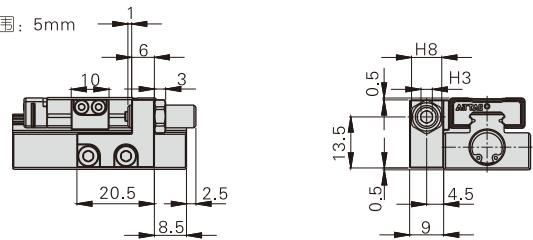

HGS8X10

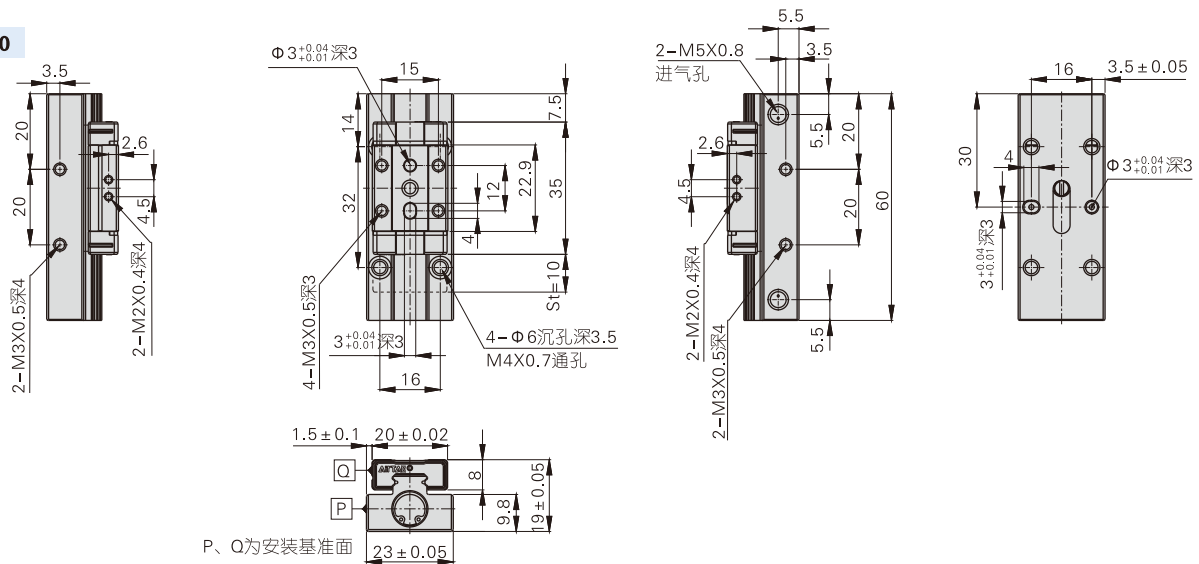

HGS8X10S

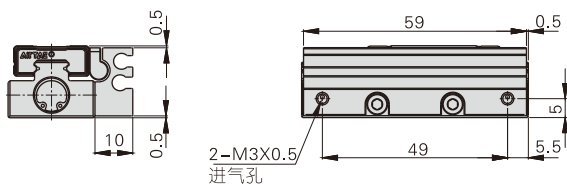

HGS8X10J

可调范围: 两侧各5mm

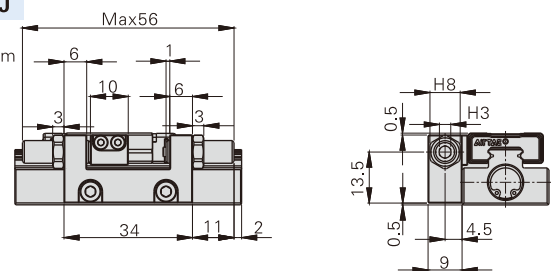

HGS系列

HGS8X15

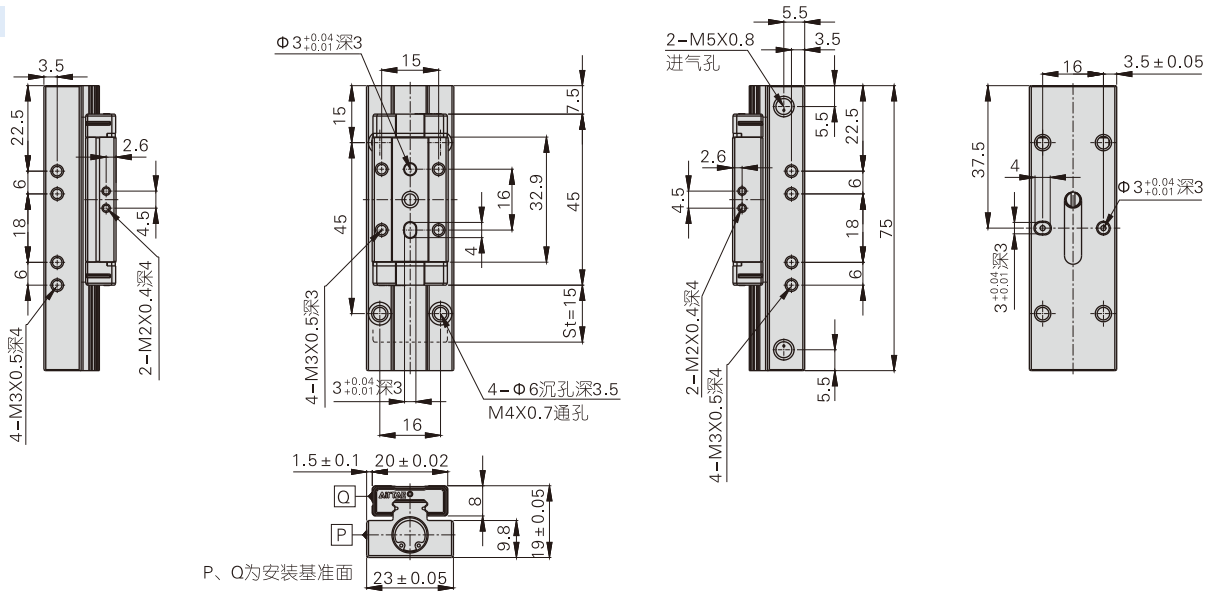

HGS8X15S

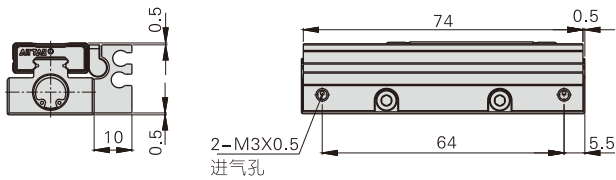

HGS8X15J

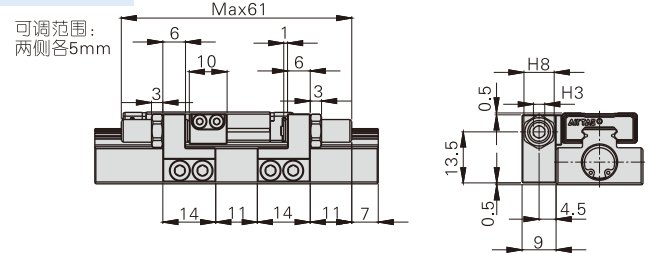

HGS8X20

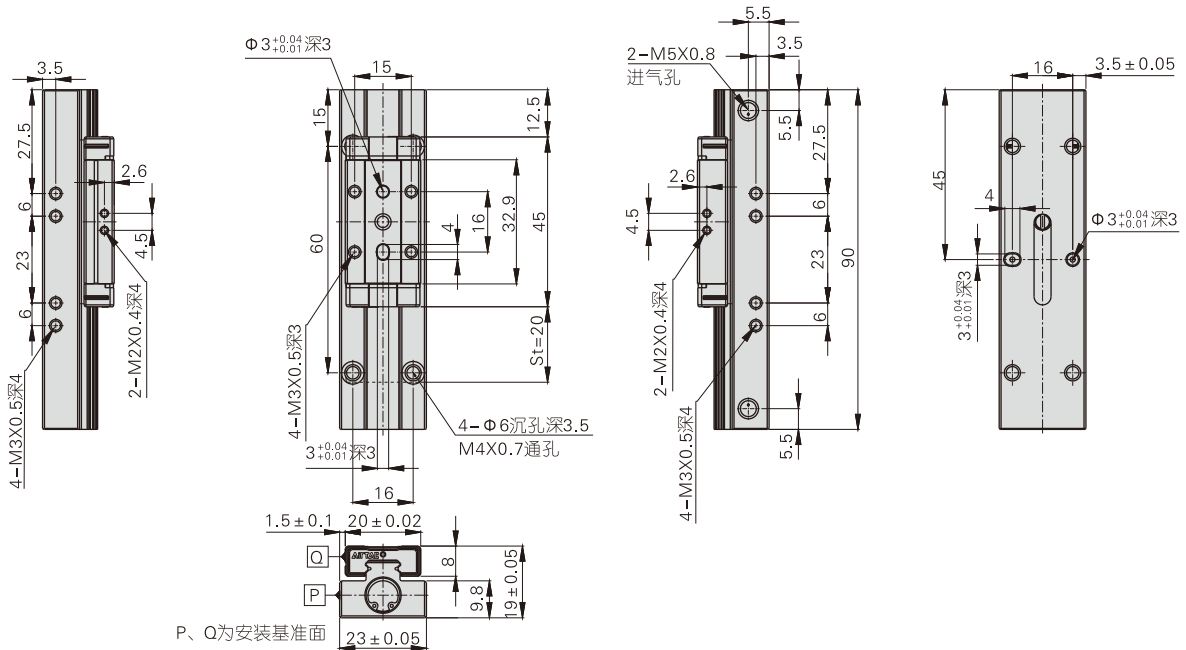

HGS8X20S

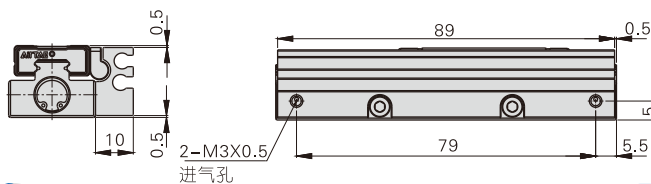

HGS8X20J

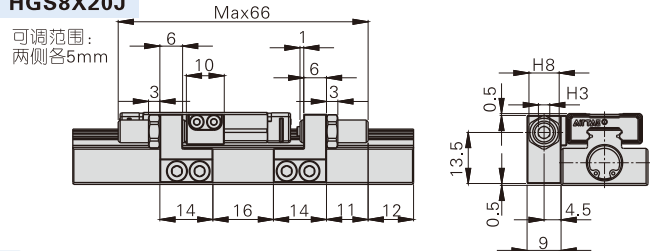

HGS系列

外部规格(HGS10)

HGS10X5

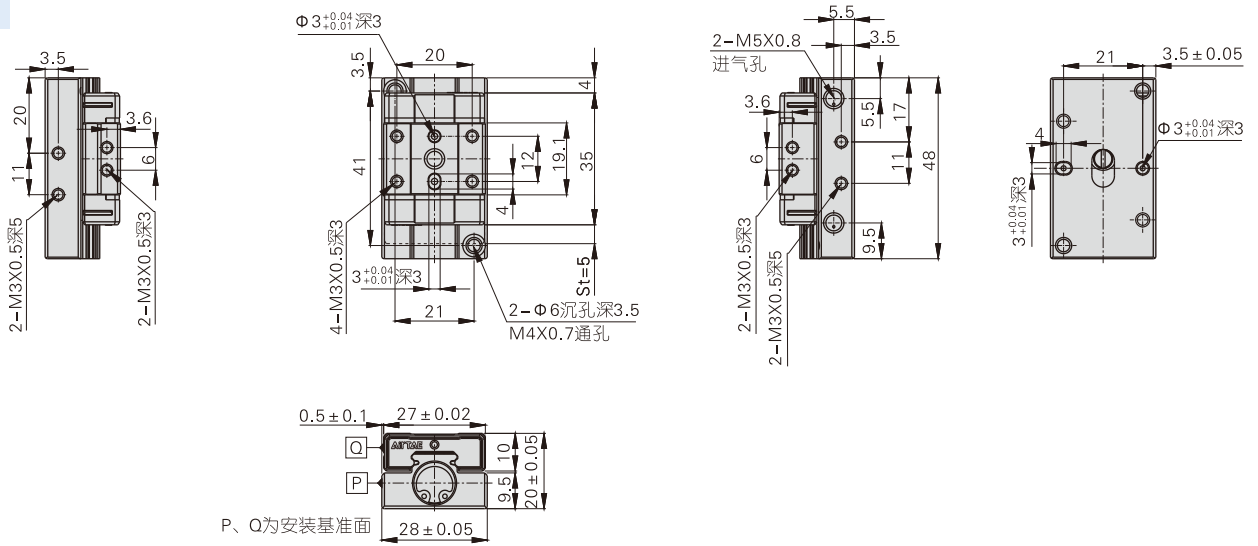

HGS10X5S

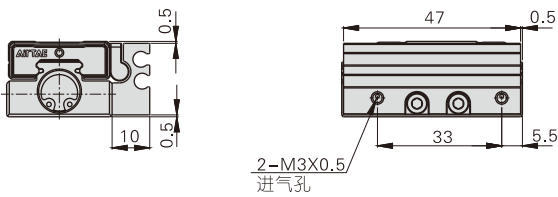

HGS10X5J

可调范围: 5mm

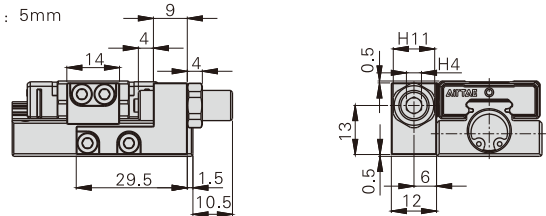

HGS10X10

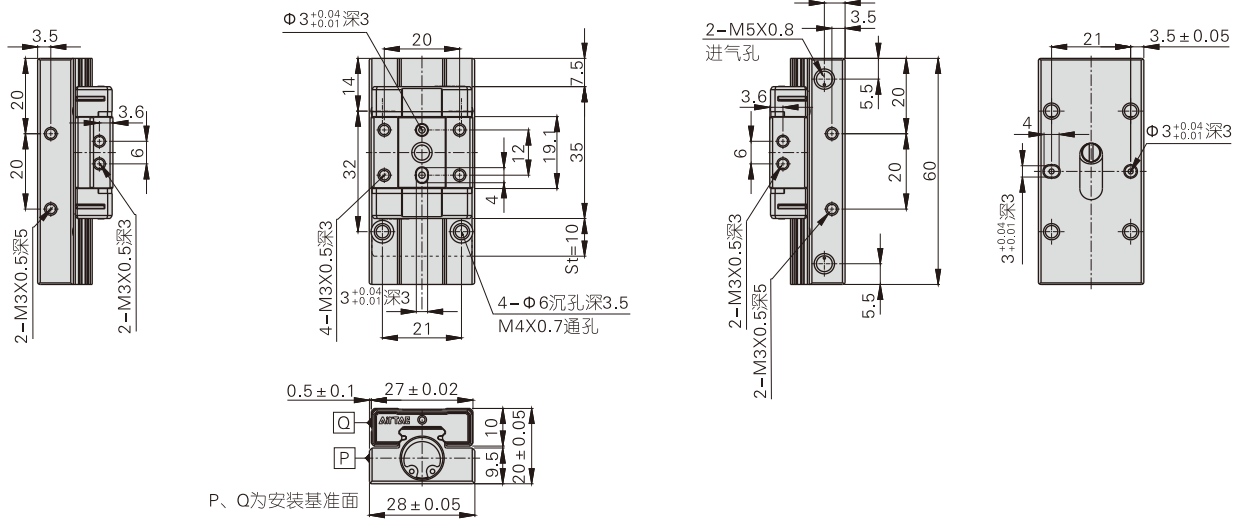

HGS10X10S

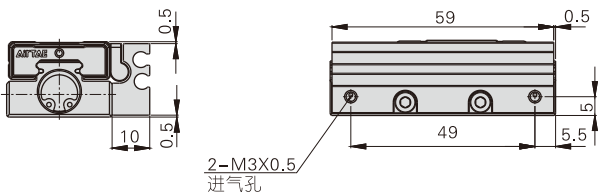

HGS10X10J

可调范围: 两侧各5mm

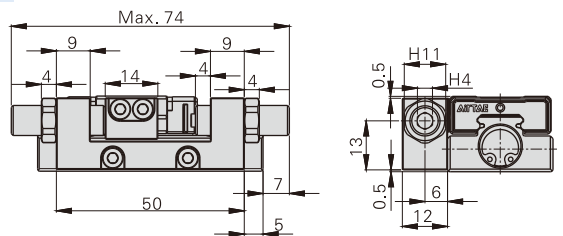

HGS系列

HGS10X15

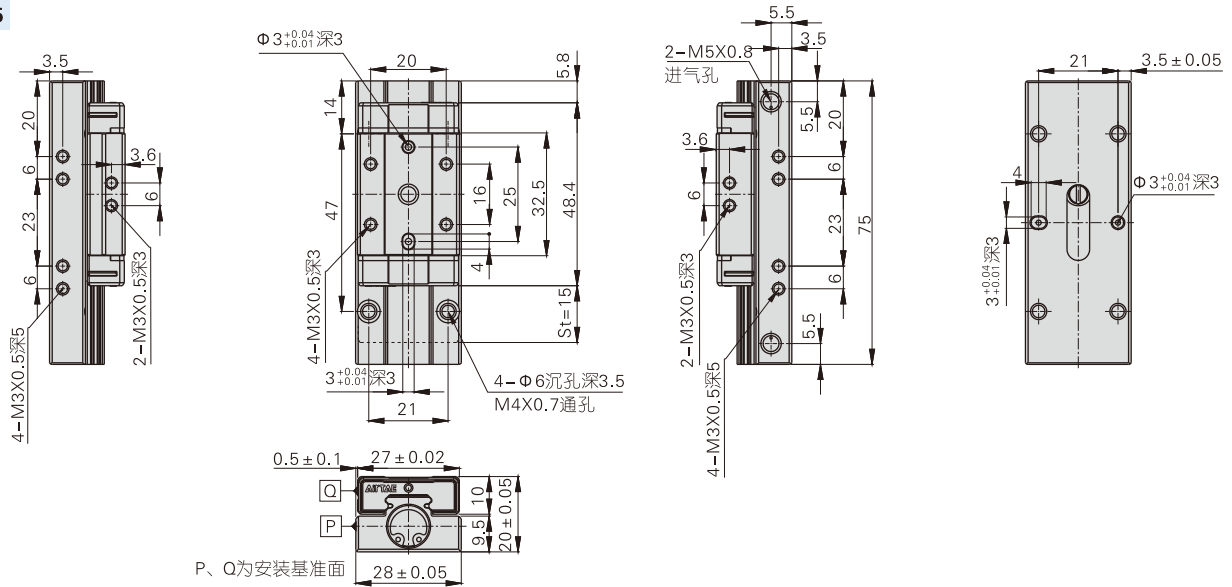

HGS10X15S

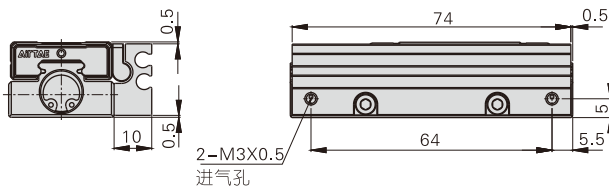

HGS10X15J

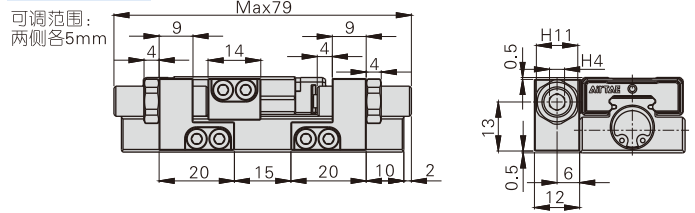

HGS10X20

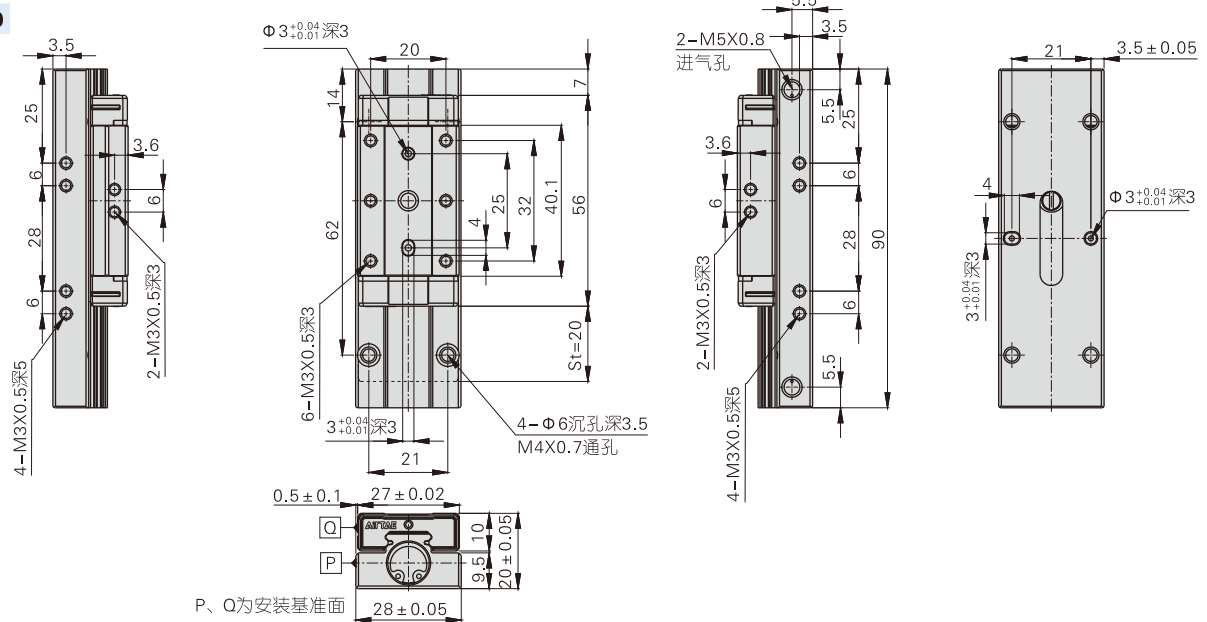

HGS10X20S

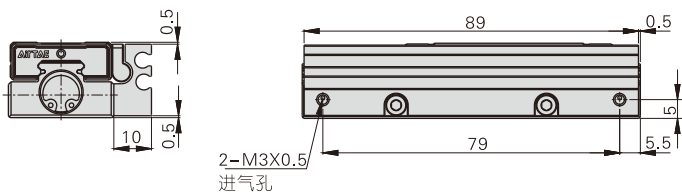

HGS10X20J

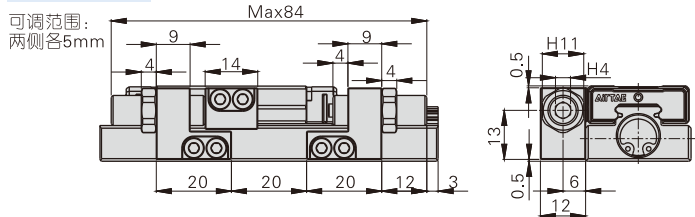

HGS系列

外部规格(HGS12)

HGS12X5

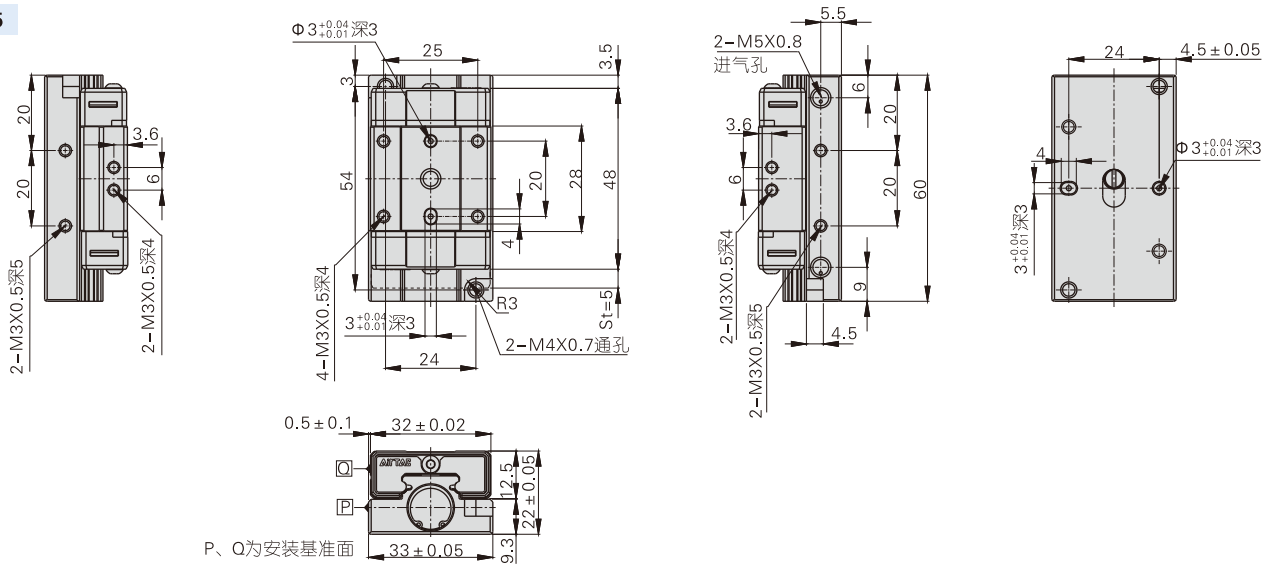

HGS12X5S

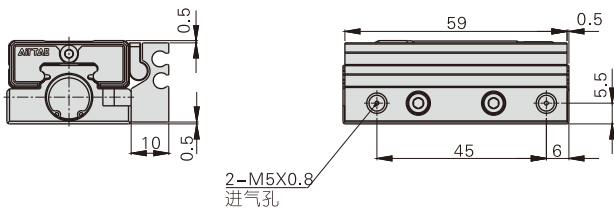

HGS12X5J

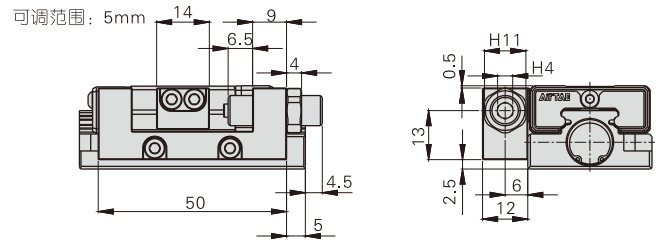

HGS12X10

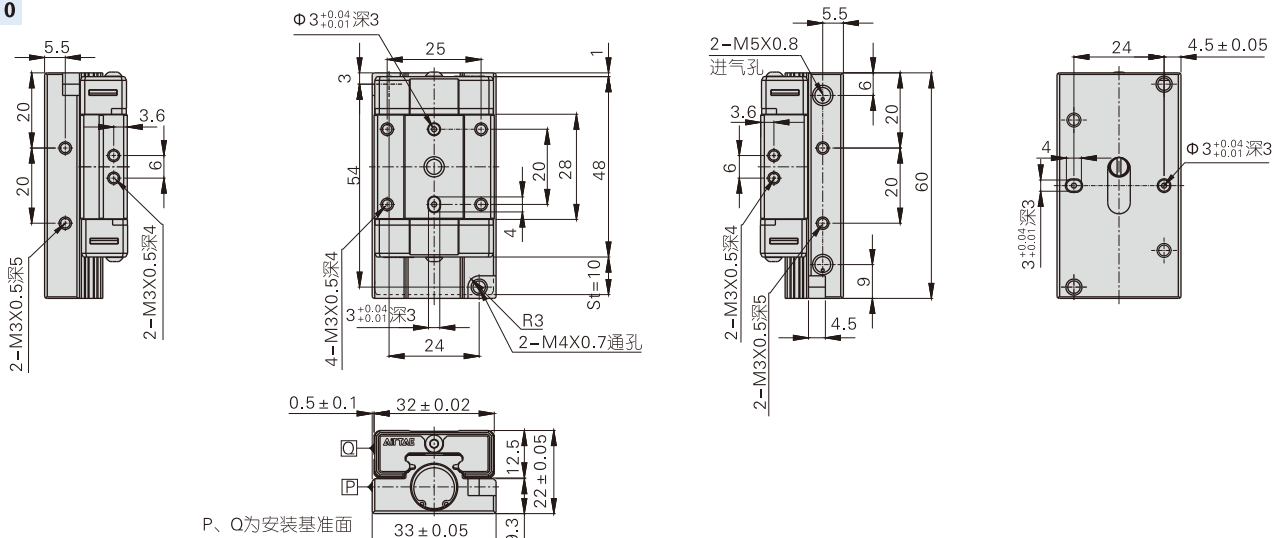

HGS12X10S

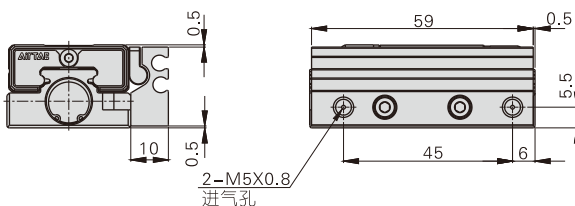

HGS12X10J

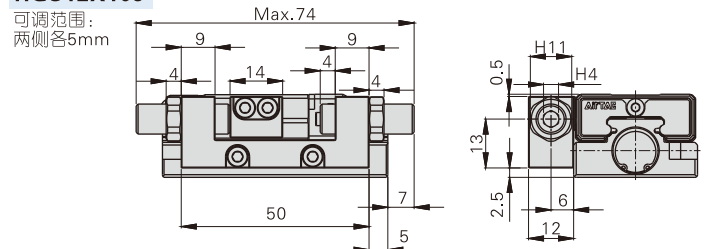

HGS系列

HGS12X20S

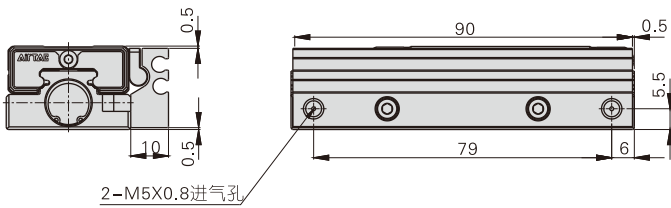

HGS12X20J

可调范围:
两侧各5mm

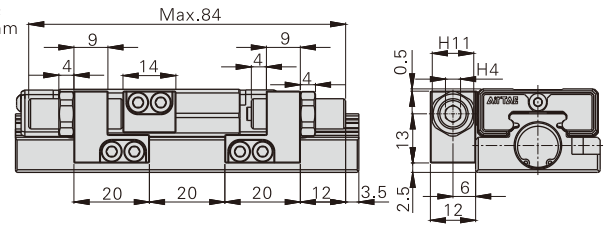

HGS12X25

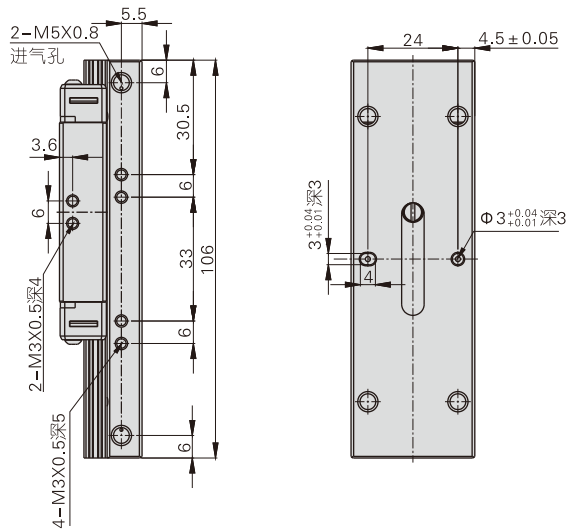
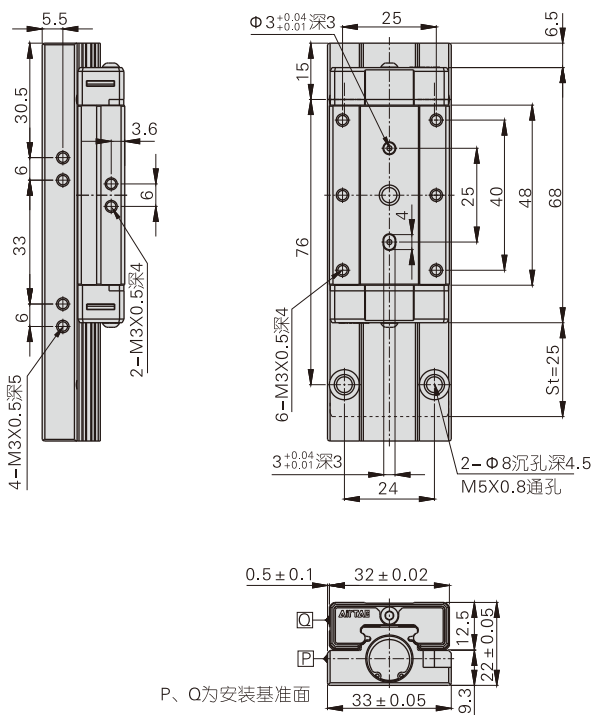

HGS12X25S

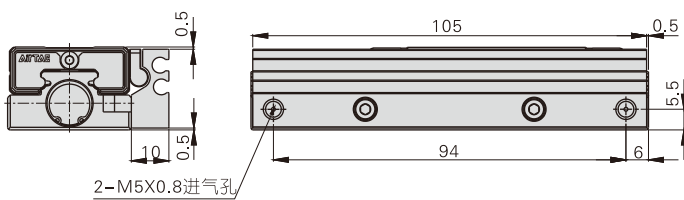

HGS12X25J

可调范围:
两侧各5mm

